



SENTINEL[®] Cases from Gemstar[®] are injection-molded cases engineered to deliver the ultimate protection for your most valuable assets—for sleek, lightweight protection that can stand up to any demand, choose SENTINEL.

Standard Features

- Injection molded construction
- Watertight, airtight, dustproof
- Automatic pressure relief valve
- Two molded-in padlock brackets
- EPDM gasket
- Military Grade Certification
- Stainless steel hardware
- Easy-open latches

Standard and Custom Options

- Offering a robust selection of custom features, colors, and sizes. For more information visit Gemstarmfg.com, or contact your local Distributor or Sales Manager.

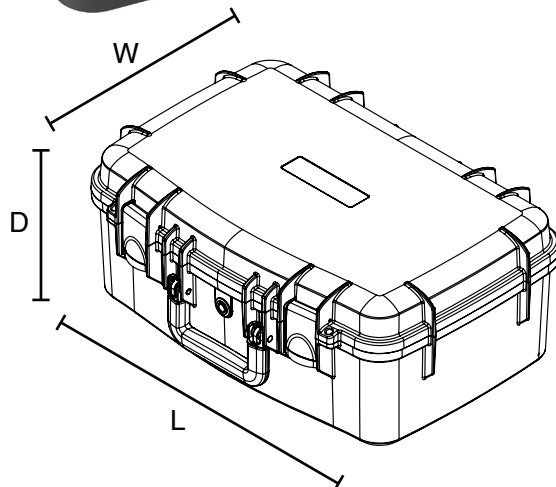

Nominal INT Dimension	19.7"L x 12.3"W x 8.1"D 500L x 312W x 206D mm
Base Depth	6.1" 155 mm
Lid Depth	2.0" 51 mm
Nominal EXT Dimension	21.4"L x 14.9"W x 8.7"D 544L x 378W x 221D mm
Approx. Weight	7.5 lbs 3.4 kg
Features	<ul style="list-style-type: none"> • Overmolded handle • Easy-open latches (2)