



SENTINEL[®] Cases from Gemstar[®] are injection-molded cases engineered to deliver the ultimate protection for your most valuable assets—for sleek, lightweight protection that can stand up to any demand, choose SENTINEL.

Standard Features

- Injection molded construction
- Watertight, airtight, dustproof
- Automatic pressure relief valve
- Two molded-in padlock brackets
- EPDM gasket
- Military Grade Certification
- Stainless steel hardware
- Easy-open latches

Standard and Custom Options

- Offering a robust selection of custom features, colors, and sizes. For more information visit Gemstarmfg.com, or contact your local Distributor or Sales Manager.

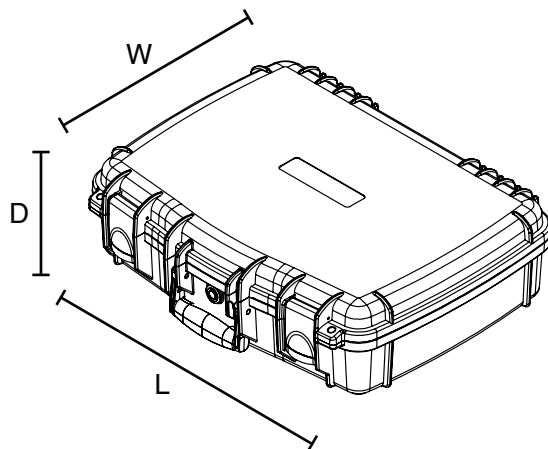

Nominal INT Dimension	18.0"L x 13.0"W x 5.0"D 457L x 330W x 127D mm
Base Depth	3.5" 89 mm
Lid Depth	1.5" 38 mm
Nominal EXT Dimension	19.7"L x 15.7"W x 5.5"D 500L x 399W x 140D mm
Approx. Weight	6.6 lbs 3.0 kg
Features	<ul style="list-style-type: none"> • Overmolded handle • Easy-open latches (2)