



STRONGHOLD[®] Cases from Gemstar[®] offer MIL-STD durability and airtight protection for high-value cargo. Featuring rotationally-molded double walls and thick corners STRONGHOLD is the choice for rugged, versatile and dependable protection.

Standard Features

- Rotationally molded, double-walled durability
- IP67 rated; watertight, airtight and dust-proof with automatic pressure relief valve
- Meets or exceeds MIL-STD 810F and meets military LLRC standards*
- Recessed, heavy-duty black stainless steel hardware
- Field serviceable hardware
- Spring-loaded handles
- Tongue & groove construction with gasket
- Interlocking, stackable design
- Choice of 10 standard colors

Guaranteed Performance*

* See website for guarantee details, complete certifications and test procedures.

Standard Models

- SH1414-1204

Standard and Custom Options

- Offering a robust selection of custom features, colors, and sizes. For more information visit **Gemstarmfg.com**, or contact your local Distributor or Sales Manager.

Standard Color Options**



** Colors are approximate and are for visual purposes only.

SH1414-1204 Top Profile

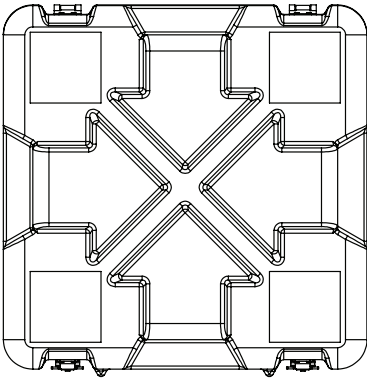

MODEL NUMBER KEY

SH14 14-12 04

Length ———— Lid
Width ———— Base
Model numbers refer to interior dimensions

SH1414-1204 Side and End Profile

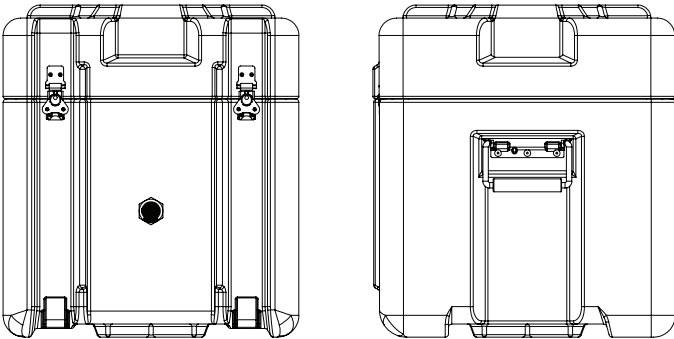

Nominal INT Dimension	14.0"L x 14.0"W x 16.8"D 355L x 355W x 426D mm
Base Depth	12.6" 320 mm
Lid Depth	4.2" 106 mm
Nominal EXT Dimension	17.3"L x 17.0"W x 19.0"D 439L x 431W x 482D mm
Approx. Weight	17.5 lbs 7.9 kg
Features	<ul style="list-style-type: none"> • Hinged lid • Stainless steel handles (2) • PRV