

8 7 6 5 4 3 2 1

D
C
B
A

D
C
B
A

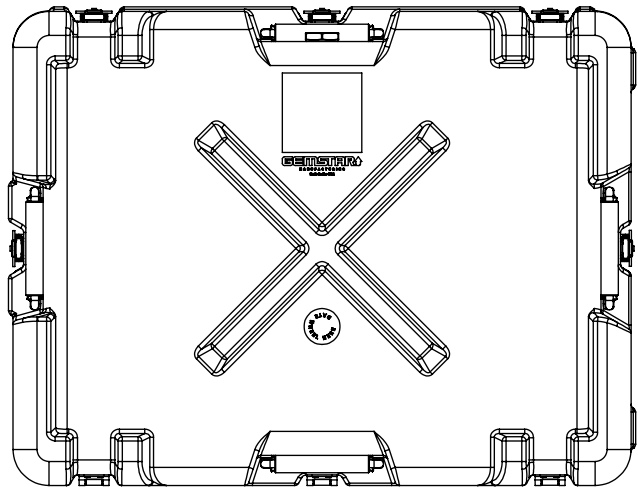
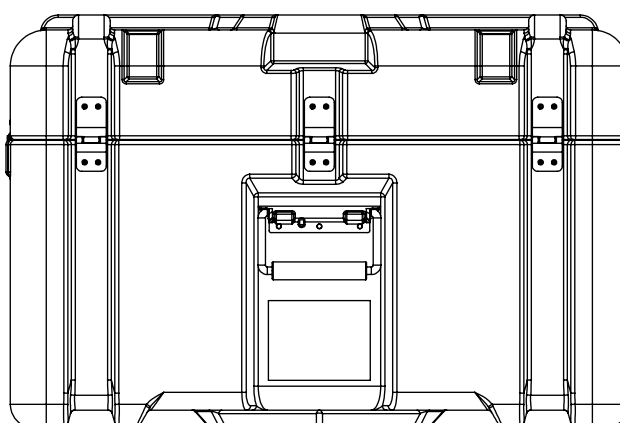
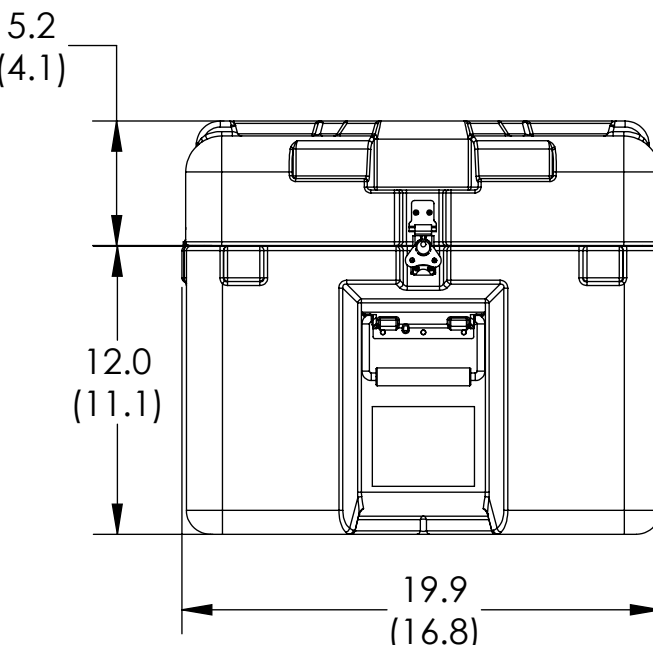
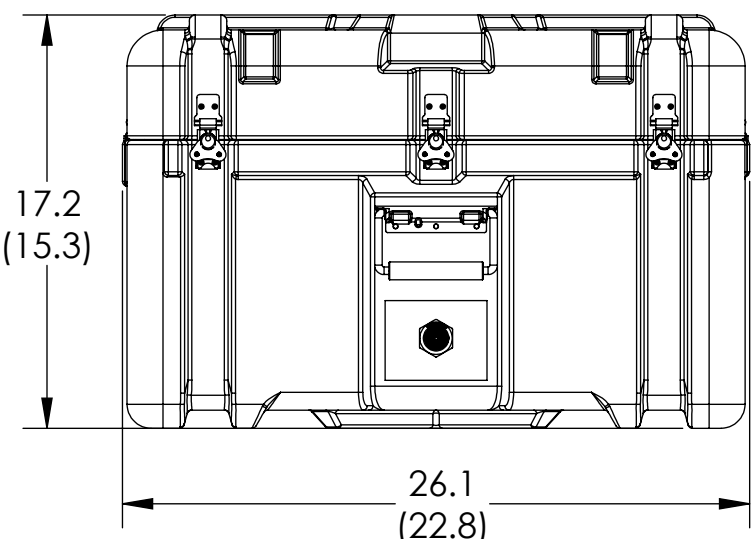
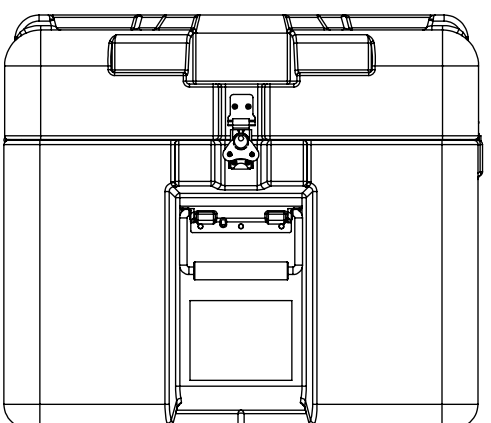
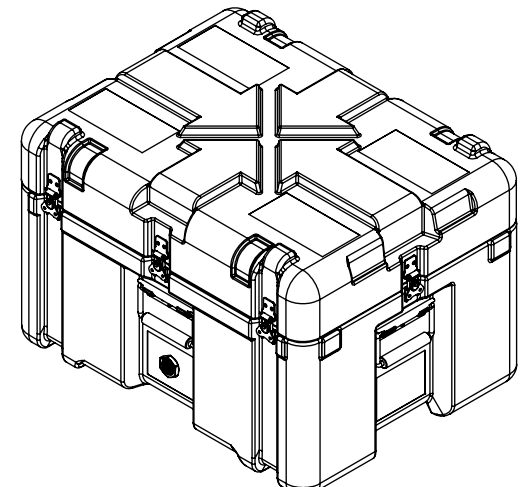
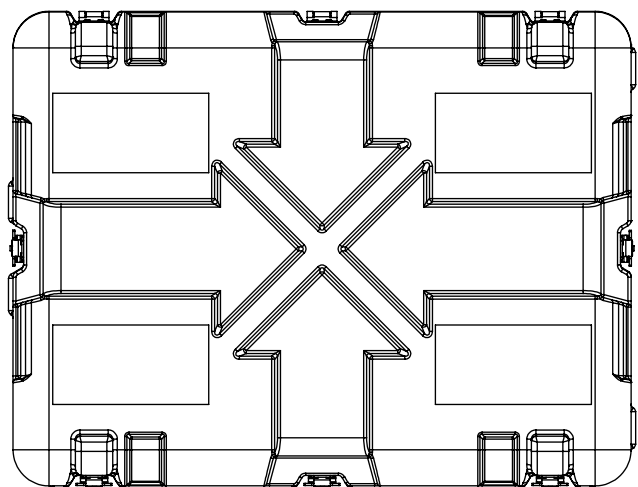

NOTE:
DIMENSIONS X.X ARE EXTERIOR DIMENSIONS
DIMENSIONS (X.X) ARE INTERIOR DIMENSIONS

SPECIALTY CASES
[DESIGN ■ SUPPORT ■ PROTECT]
P.O. Box 936
Sykesville, MD 21784
Phone: (800) 267-1674
<https://www.specialtycases.com>

SOURCE SUPPLIER Gemstar Manufacturing 103 Mensing Way Cannon Falls, MN 55009	CAGE CODE 36NE1	PROPRIETARY AND CONFIDENTIAL THE INFORMATION CONTAINED IN THIS DRAWING IS THE SOLE PROPERTY OF GEMSTAR MANUFACTURING. ANY REPRODUCTION IN PART OR AS A WHOLE WITHOUT THE WRITTEN PERMISSION OF GEMSTAR MANUFACTURING IS PROHIBITED.	UNLESS OTHERWISE SPECIFIED:		NAME	DATE	GEMSTAR MANUFACTURING TITLE: SH2216-1104
			DIMENSIONS ARE IN INCHES TOLERANCES MOLDED FEATURES +/- .030 + .005 IN/IN 5 AXIS MACHINED FEATURES FEATURE SIZE +/- .005 FEATURE TO FEATURE +/- 0.010 FIXTURE TO FEATURE +/- 0.031 HAND ROUTED FEATURE +/- .031	INTERPRET GEOMETRIC TOLERANCING PER: MATERIAL FINISH	DRAWN CHECKED ENG APPR. MFG APPR. Q.A. COMMENTS:		
DO NOT SCALE DRAWING			SIZE	DWG. NO.	REV	SCALE: 1:1 SHEET 1 OF 1	

8 7 6 5 4 3 2 1