



**STRONGHOLD<sup>®</sup> Cases from Gemstar<sup>®</sup> offer MIL-STD durability and airtight protection for high-value cargo. Featuring rotationally-molded double walls and thick corners STRONGHOLD is the choice for rugged, versatile and dependable protection.**

**Standard Features**

- Rotationally molded, double-walled durability
- IP67 rated; watertight, airtight and dust-proof with automatic pressure relief valve
- Meets or exceeds MIL-STD 810F and meets military LLRC standards\*
- Recessed, heavy-duty black stainless steel hardware
- Field serviceable hardware
- Spring-loaded handles
- Tongue & groove construction with gasket
- Interlocking, stackable design
- Choice of 10 standard colors

**Guaranteed Performance\***

\* See website for guarantee details, complete certifications and test procedures.

**Standard Models**

- SH3024-0504
- SH3024-0514
- SH3024-1504
- SH3024-1514

**Standard and Custom Options**

- Offering a robust selection of custom features, colors, and sizes. For more information visit **Gemstarmfg.com**, or contact your local Distributor or Sales Manager.

**Standard Color Options\*\***



\*\* Colors are approximate and are for visual purposes only.

**SH3024-0504** Top Profile

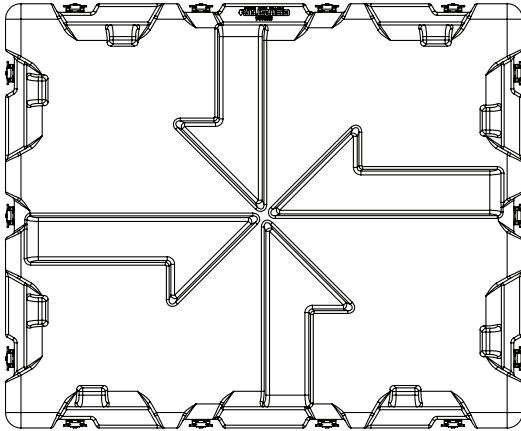

MODEL NUMBER KEY

**SH30 24-05 04**

Length ———— Lid  
Width ———— Base  
Model numbers refer to interior dimensions

**SH3024-0504** Side and End Profile

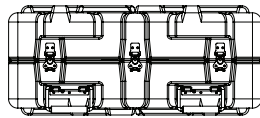
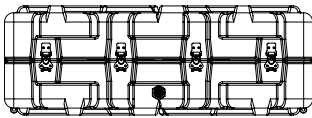

Nominal INT Dimension	30.3"L x 24.3"W x 10.0"D 769L x 617W x 253D mm
Base Depth	5.2" 132 mm
Lid Depth	4.8" 121 mm
Nominal EXT Dimension	33.5"L x 27.5"W x 11.9"D 850L x 698W x 302D mm
Approx. Weight	30.0 lbs 13.6 kg
Features	<ul style="list-style-type: none"> <li>• Removable lid</li> <li>• Stainless steel handles (4)</li> <li>• PRV</li> </ul>

**SH3024-0514** Top Profile

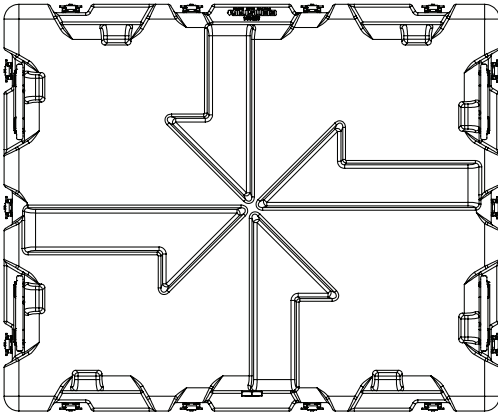

MODEL NUMBER KEY

**SH30 24-05 14**

Length ———— Lid  
Width ———— Base  
Model numbers refer to interior dimensions

**SH3024-0514** Side and End Profile

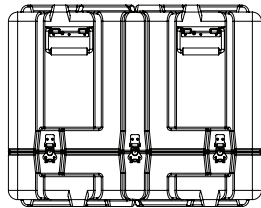
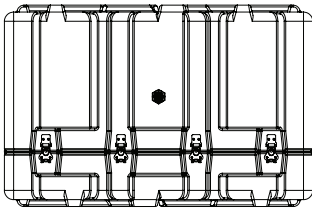

Nominal INT Dimension	30.3"L x 24.3"W x 20.0"D 769L x 617W x 507D mm
Base Depth	5.2" 132 mm
Lid Depth	14.8" 375 mm
Nominal EXT Dimension	33.5"L x 27.5"W x 21.9"D 850L x 698W x 556D mm
Approx. Weight	38.2 lbs 17.4 kg
Features	<ul style="list-style-type: none"> <li>• Removable lid</li> <li>• Stainless steel handles (4)</li> <li>• PRV</li> </ul>

**SH3024-1504** Top Profile

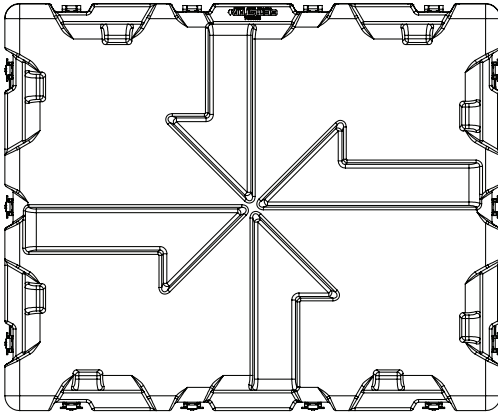

MODEL NUMBER KEY

**SH30 24-15 04**

Length ———— Lid  
Width ———— Base  
Model numbers refer to interior dimensions

**SH3024-1504** Side and End Profile

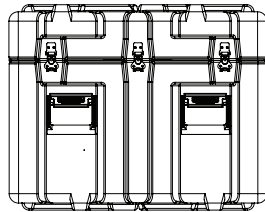
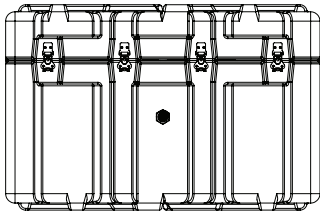

Nominal INT Dimension	30.3"L x 24.3"W x 20.0"D 769L x 617W x 507D mm
Base Depth	15.2" 386 mm
Lid Depth	4.8" 121 mm
Nominal EXT Dimension	33.5"L x 27.5"W x 21.9"D 850L x 698W x 556D mm
Approx. Weight	38.2 lbs 17.4 kg
Features	<ul style="list-style-type: none"> <li>• Hinged lid</li> <li>• Textured plastic handles (4)</li> <li>• PRV</li> </ul>



**SH3024-1514** Top Profile

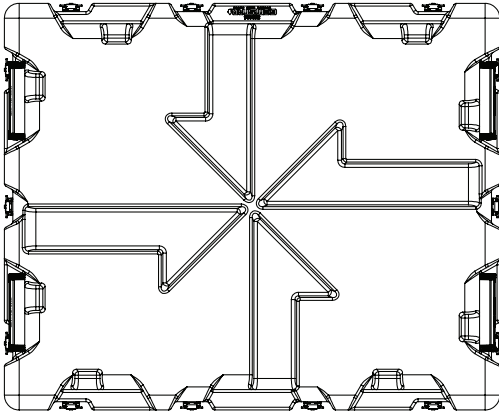

MODEL NUMBER KEY

**SH30 24-15 14**

Length ———— Lid  
Width ———— Base  
Model numbers refer to interior dimensions

**SH3024-1514** Side and End Profile

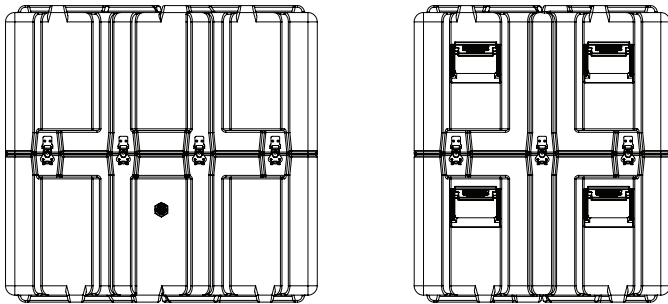

Nominal INT Dimension	30.3"L x 24.3"W x 30.0"D 769L x 617W x 761D mm
Base Depth	15.2" 386 mm
Lid Depth	14.8" 375 mm
Nominal EXT Dimension	33.5"L x 27.5"W x 31.9"D 850L x 698W x 810D mm
Approx. Weight	48.0 lbs 21.8 kg
Features	<ul style="list-style-type: none"> <li>• Removable lid</li> <li>• Textured plastic handles (8)</li> <li>• PRV</li> </ul>