

8 7 6 5 4 3 2 1

D

C

B

A

D

C

B

A

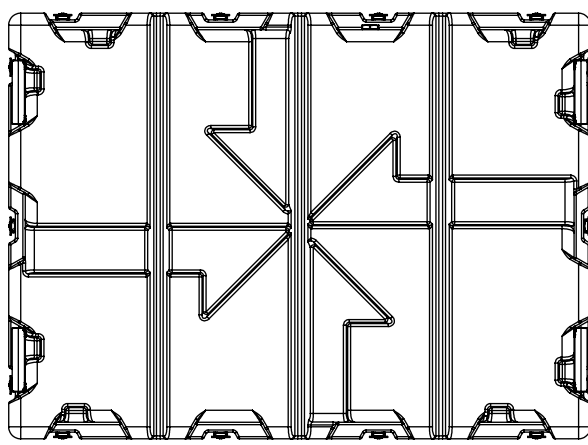
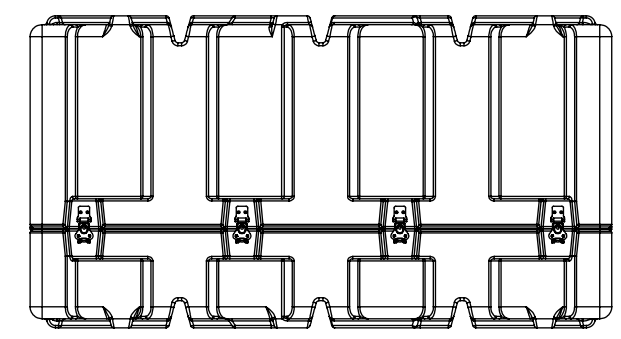
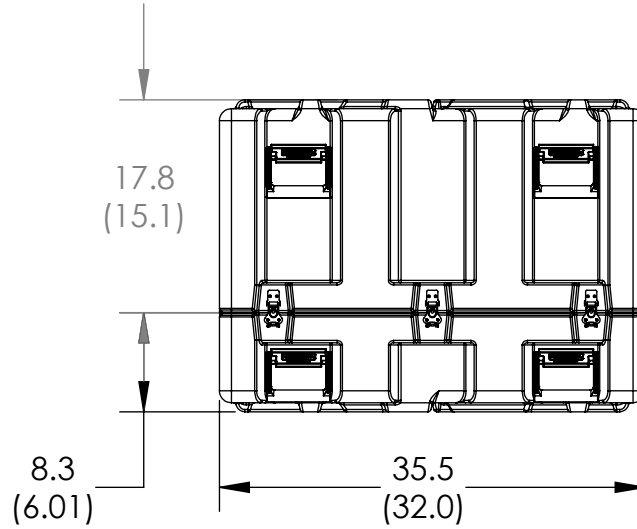
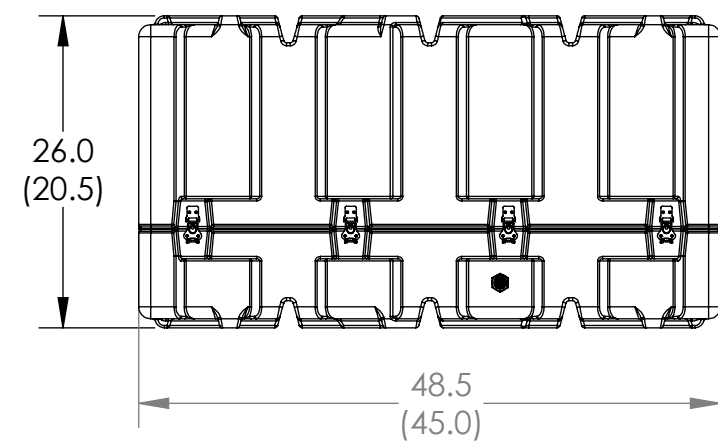
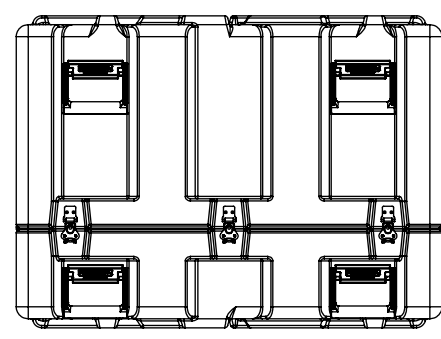
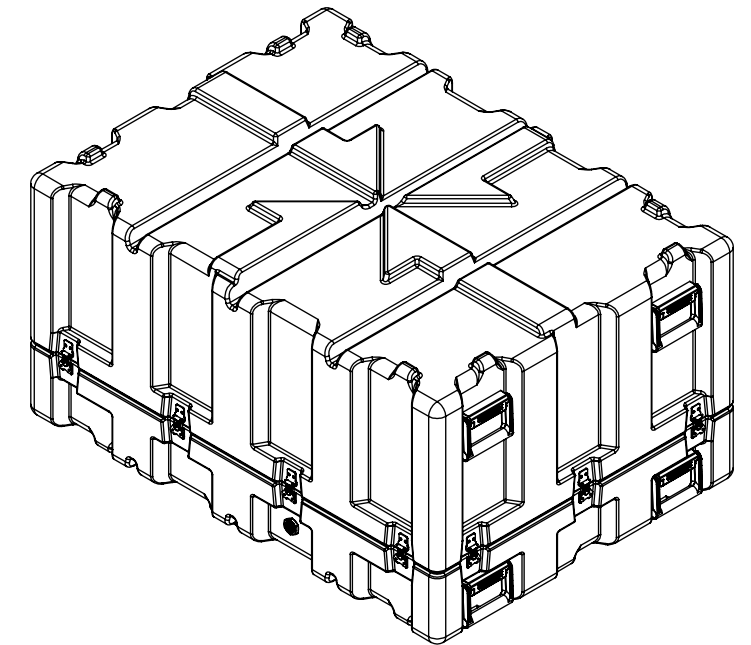
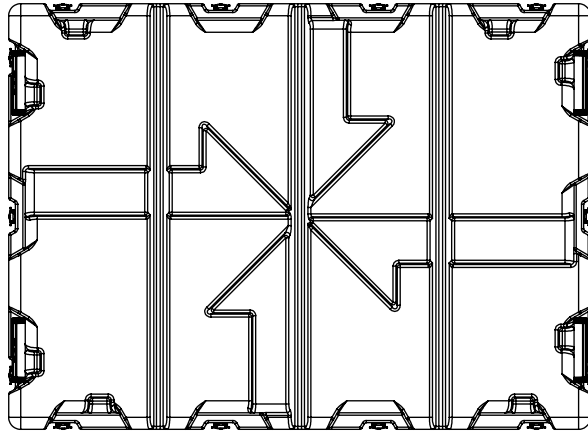

NOTE:
DIMENSIONS X.X ARE EXTERIOR DIMENSIONS
DIMENSIONS (X.X) ARE INTERIOR DIMENSIONS

SPECIALTY CASES
[DESIGN ■ SUPPORT ■ PROTECT]
P.O. Box 936
Sykesville, MD 21784
Phone: (800) 267-1674
<https://www.specialtycases.com>

SOURCE SUPPLIER Gemstar Manufacturing 103 Mensing Way Cannon Falls, MN 55009 CAGE CODE 36NE1 PROPRIETARY AND CONFIDENTIAL COMPUTER CONTROLLED DOCUMENT MANUAL ALTERATIONS PROHIBITED. INFORMATION CONTAINED IN THIS DRAWING ARE THE SOLE PROPERTY OF GEMSTAR MANUFACTURING. ANY REPRODUCTION IN PART OR AS A WHOLE WITHOUT THE WRITTEN PERMISSION OF GEMSTAR MANUFACTURING IS PROHIBITED.	UNLESS OTHERWISE SPECIFIED: DIMENSIONS ARE IN INCHES TOLERANCES MOLDED FEATURES +/- .030 + .005 IN/IN 5 AXIS MACHINED FEATURES FEATURE SIZE +/- .005 FEATURE TO FEATURE +/- 0.010 FIXTURE TO FEATURE +/- 0.031 HAND ROUTED FEATURE +/- .031	NAME	DATE	GEMSTAR MANUFACTURING TITLE: <h1>SH4532-0614</h1>
		DRAWN CHECKED ENG APPR. MFG APPR. Q.A. COMMENTS:		
	INTERPRET GEOMETRIC TOLERANCING PER: MATERIAL FINISH DO NOT SCALE DRAWING			SIZE B DWG. NO. REV SCALE: 1:16 SHEET 1 OF 1

8 7 6 5 4 3 2 1